

INSTRUCTION MANUAL

© B62-0810-00 (K,E)
09 08 07 06 05 04 03 02 01 00**ATTENTION:** The charger operates on the following voltages:

U.S.A./Canada: 120 V AC, 60 Hz only

Europe: 230 V AC, 50/60 Hz

Check the rating label attached to the bottom of the charger for other important specifications.

UNPACKING

Item	Part Number	Qty
Charger	—	1
AC adapter (U.S.A./Canada)	W08-0477-XX	1
AC adapter (Europe)	W08-0478-XX	1
Instruction manual	B62-0810-XX	1

APPLICABLE NiCd BATTERY PACKS

Charge only the NiCd battery packs listed below. Other types of batteries may burst causing personal injury.

- PB-38 (6 V, 650 mAh)
- PB-39 (9.6 V, 600 mAh)

ORIENTATION

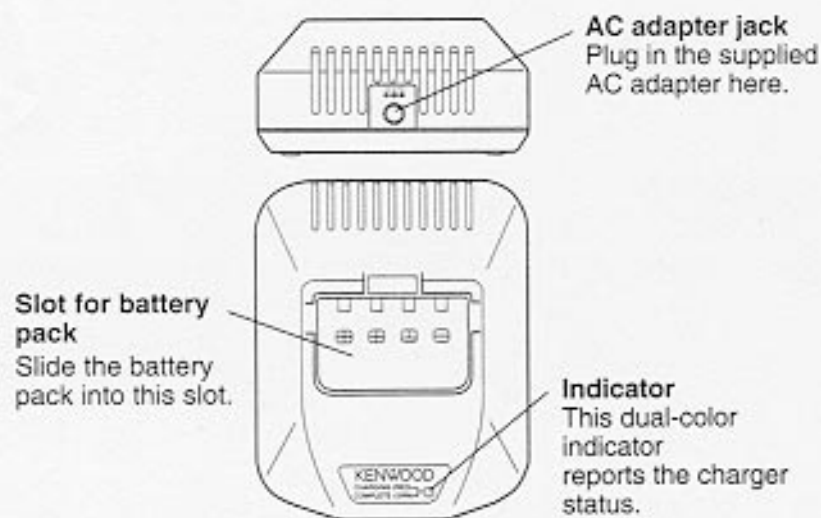

CHARGER STATUS TABLE

Indicator Color	Meaning
Red	Indicates a battery pack is in the slot and that charging has started.
Blinking Red	Indicates a defective battery pack.
Green	Indicates charging has completed.

SPECIFICATIONS

Dimensions: 105 x 55 x 135 mm
(W x H x D) 4 1/8 x 2 11/64 x 5 5/16 in
Weight (charger only): Approx. 160 g / 5.6 oz

CHARGING PROCEDURE

ATTENTION: Always switch OFF a transceiver equipped with a NiCd battery pack before inserting the transceiver into the charger.

- 1 Plug the AC adapter cable into the adapter jack located on the rear of the charger.

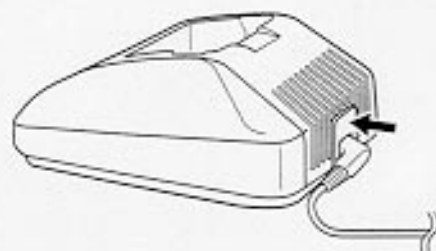

- 2 Plug the AC adapter into an AC outlet.

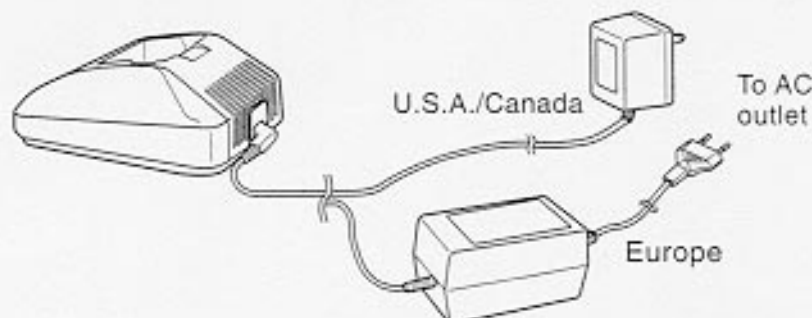

- 3 Slide a NiCd battery pack or a transceiver equipped with a battery pack into the charging slot.
 - Make sure that the metal contacts on the pack mate securely with the charger terminals.
 - The indicator lights and charging starts.

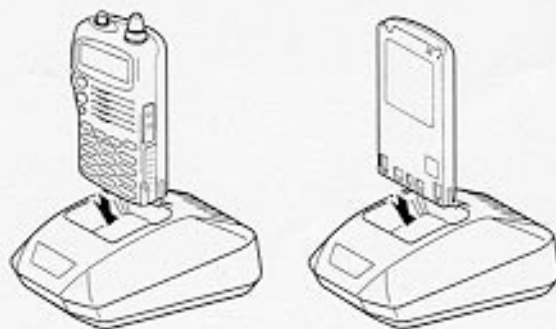

- 4 When charging is completed, the indicator lights green. Remove the battery pack or the transceiver from the charging slot.
 - When the charger will not be used for a long time, unplug the AC adapter from the AC outlet.

APPROXIMATE CHARGING TIMES

Battery Pack	Voltage	Battery Capacity	Charging Time
PB-38	6.0 V	650 mAh	Approx. 60 minutes
PB-39	9.6 V	600 mAh	Approx. 90 minutes

CHARGING TIPS

- *Using the transceiver while charging its battery pack will interfere with correct charging.*
- *Repeatedly recharging a fully charged battery pack, or almost fully charged pack, shortens its operating time. To resolve this problem, use the pack until it is completely discharged. Then recharge the pack to full capacity.*
- *If the operating time of a battery pack decreases although the battery pack is fully and correctly charged, the battery pack life is over. Replace the battery pack.*
- *The battery life in charge/discharge cycles is approximately 300. However, overcharging and excessive discharging shortens battery pack life.*
- *The ambient temperature should be from 5°C to 40°C while charging is in progress.*
- *The charging times shown in the table are obtained when a battery pack discharged to 1 V/cell is charged at normal temperatures. This charging time varies depending on the degree of discharge and the ambient charging temperature.*
- *This charger may be suitable to charge battery packs not listed in the battery pack table due to further technology development. In this case, check your transceiver Instruction Manual to confirm whether this charger is suitable.*

SAFETY PRECAUTIONS

Please read all safety precautions before using this charger. For best results, be aware of all warnings on the charger, the battery pack, and the product using the battery pack. Follow the provided operating instructions, and retain them for future reference.

- 1 Do not disassemble the charger. Incorrect reassembly can cause fire or electric shock.
- 2 Use of an attachment not recommended by nor sold by **KENWOOD** can cause fire, electric shock, or injury.
- 3 Do not expose the charger to rain or moisture to avoid the risk of fire or electric shock.
- 4 Do not use an extension cable unless absolutely necessary. Improper extension cables can cause fire or electric shock. If an extension cable is required, observe the following points:
 - a) The quantity, size, and shape of pins on the extension cable plugs must be the same as on the AC adapter supplied with the charger.
 - b) The extension cable must be properly wired and in good electrical condition.
 - c) The wire size must be adequate to carry the current required by this charger.

Extension cables shorter than 100 feet:
Wire size must be 18 AWG or larger

Extension cables 100 to 150 feet inclusive:
Wire size must be 16 AWG or larger
- 5 Always remove the AC adapter from a wall outlet before attempting to inspect or clean the charger. Removing the battery pack or changing the controls does not remove the AC voltage from the charger.
- 6 Position the AC adapter cable so it will not be stepped on, tripped over, nor subjected to damage.
- 7 Always remove the AC adapter from an AC wall outlet by pulling on the adapter rather than the cable.
- 8 Do not use the charger if it has a damaged AC adapter or adapter cable, or if the charger has been damaged in any way. Contact your **KENWOOD** dealer to replace or repair the damaged part.
- 9 Prevent strong impacts, such as caused by dropping, to avoid damaging the charger.
- 10 Do not use the charger in hot or humid environments, in direct sunlight, nor near heaters.

11 Do not use solvents such as benzene or paint thinner to clean the charger.

12 Use only the supplied AC adapter.

One or more of the following statements may be applicable to this equipment.

FCC WARNING

This equipment generates or uses radio frequency energy. Changes or modifications to this equipment may cause harmful interference unless the modifications are expressly approved in the instruction manual. The user could lose the authority to operate this equipment if an unauthorized change or modification is made.

INFORMATION TO THE DIGITAL DEVICE USER REQUIRED BY THE FCC

This equipment has been tested and found to comply with the limits for a Class B digital device, pursuant to Part 15 of the FCC Rules. These limits are designed to provide reasonable protection against harmful interference in a residential installation.

This equipment generates, uses and can generate radio frequency energy and, if not installed and used in accordance with the instructions, may cause harmful interference to radio communications. However, there is no guarantee that the interference will not occur in a particular installation. If this equipment does cause harmful interference to radio or television reception, which can be determined by turning the equipment off and on, the user is encouraged to try to correct the interference by one or more of the following measures:

- *Reorient or relocate the receiving antenna.*
- *Increase the separation between the equipment and receiver.*
- *Connect the equipment to an outlet on a circuit different from that to which the receiver is connected.*
- *Consult the dealer for technical assistance.*

■ CIRCUIT DIAGRAM (W02-1928-08)

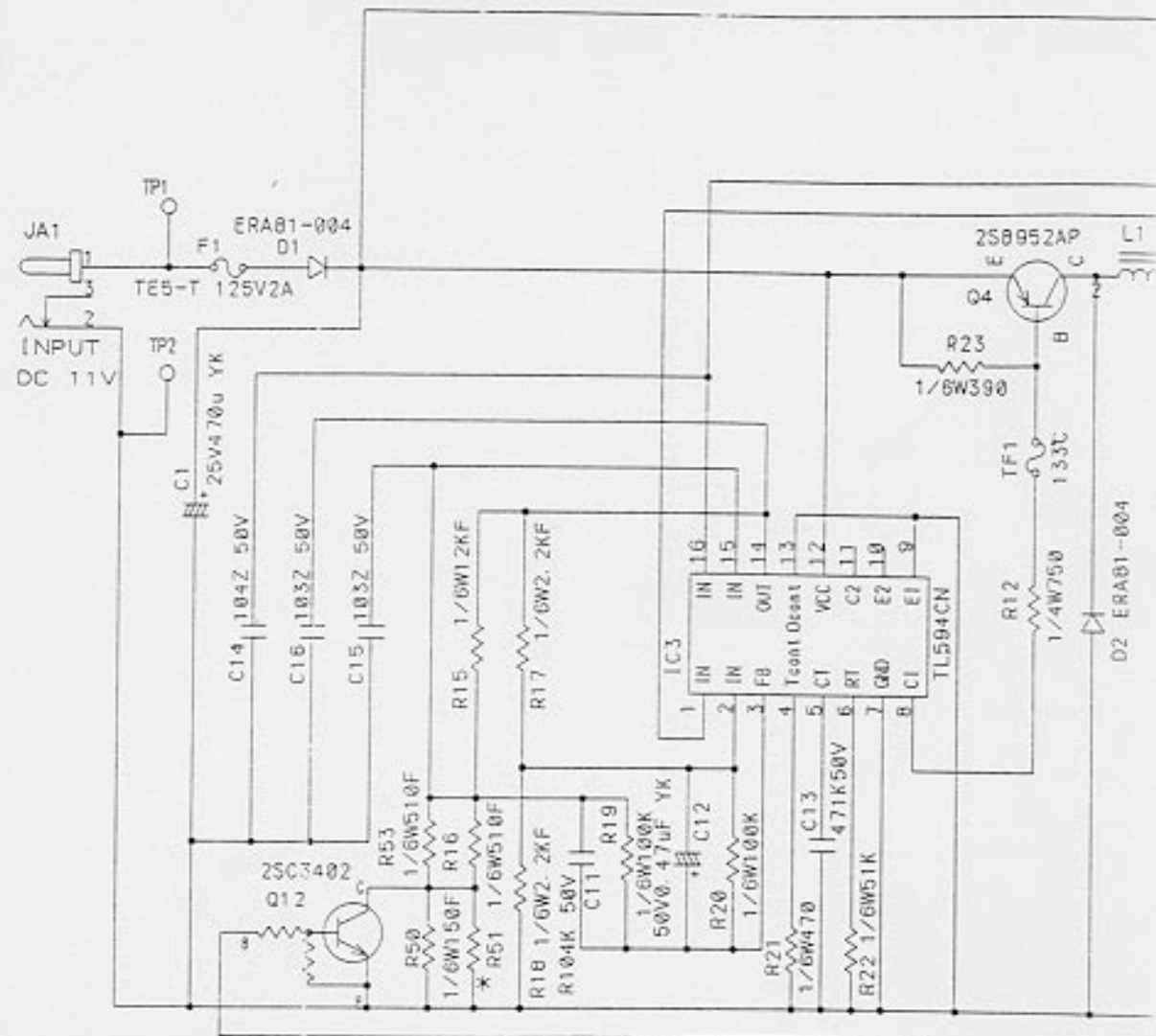

■ PC BOARD VIEW (W02-1928-08) Component side view

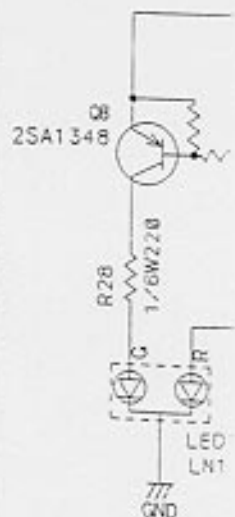
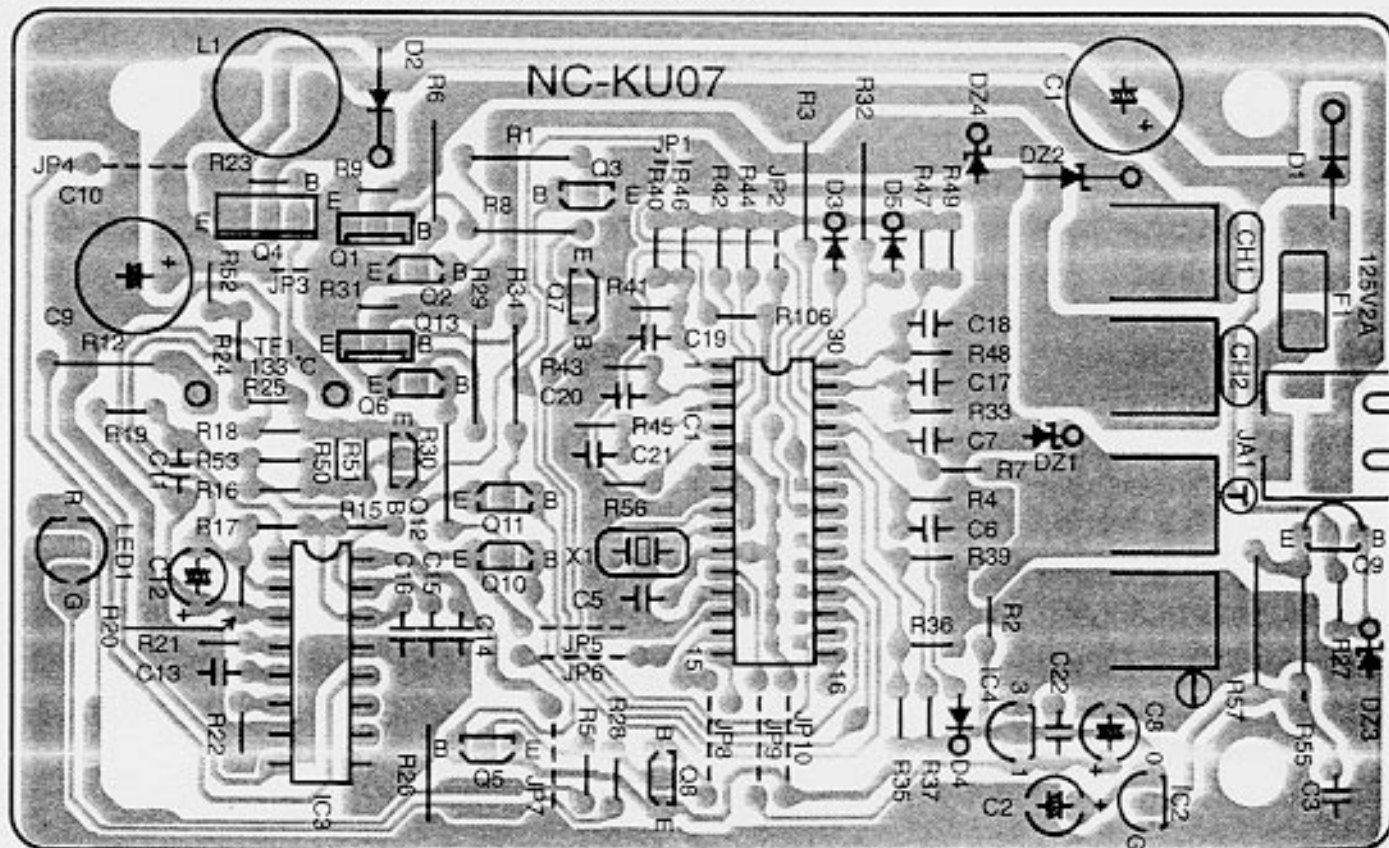

Note: Unless otherwise indicated, resistance values are in ohms. + indicates nominal value.

TH-G71A/E

RAPID CHARGER

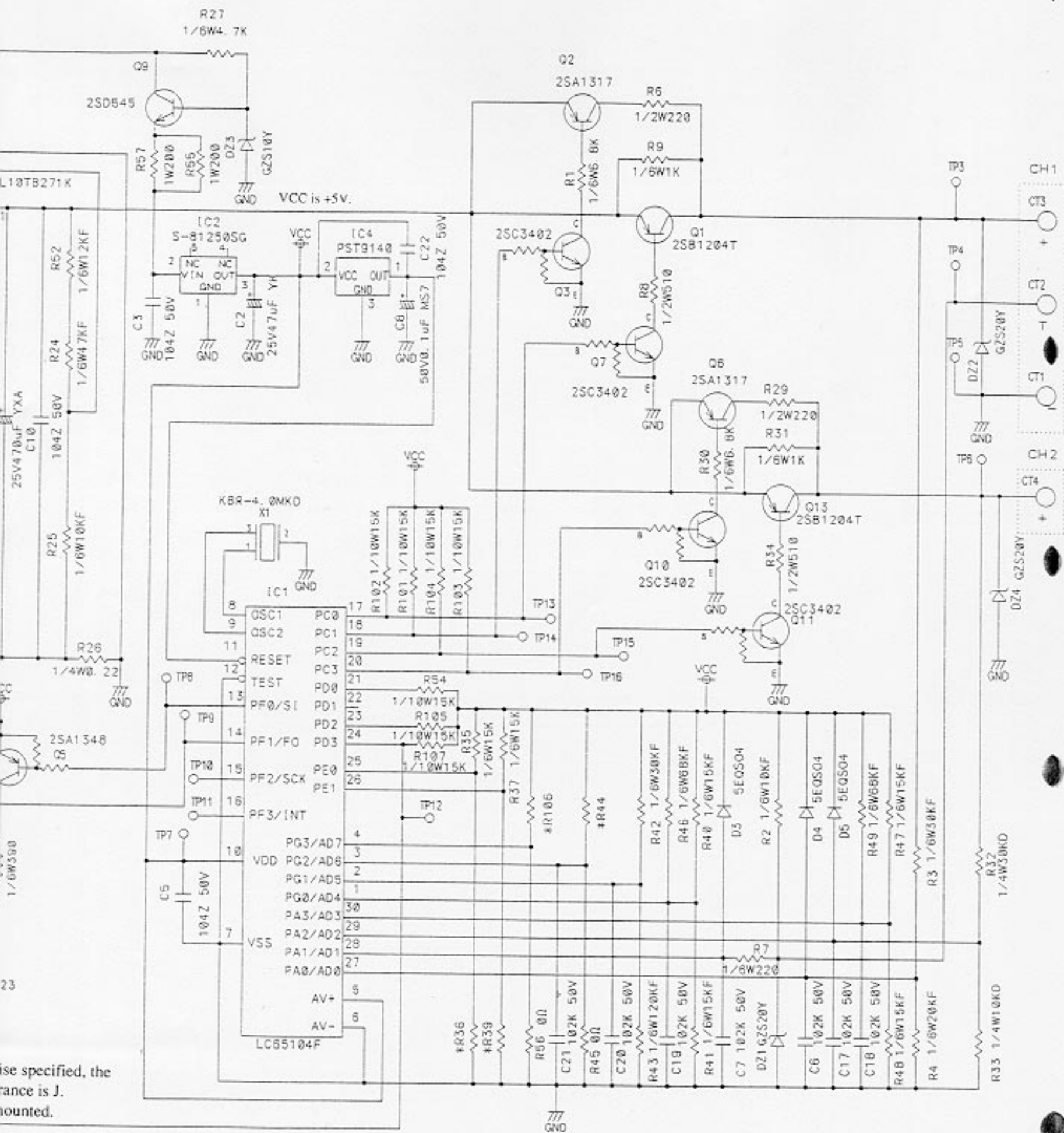

use specified, the
 tolerance is J.
 mounted.